

# MORNSUN



## WRA\_LT-2W & WRB\_LT-2W Series 2W, WIDE INPUT, ISOLATED & REGULATED SINGLE/DUAL OUTPUT DC/DC CONVERTER

RoHS

### FEATURES

Wide (2:1) input range  
Operating temperature: -40°C ~ +85°C  
1500VDC isolation  
No heat sink required  
Internal SMD construction  
MTBF>1,000,000 hours  
Short circuit protection(Automatic recovery)  
Industry standard pinout  
RoHS Compliance

### APPLICATIONS

The WRA\_LT-2W & WRB\_LT-2W Series are specially designed for applications where a wide range input voltage power supplies are isolated from the input power supply in a distributed power supply system on a circuit board.

These products apply to:

- 1) Where the voltage of the input power supply is wide range(voltage range  $\leq 2:1$ );
- 2) Where isolation is necessary between input and output (Isolation Voltage  $\leq 1500\text{VDC}$ );
- 3) Where the regulation of the output voltage and the output ripple noise are demanded.

### PRODUCT PROGRAM

Part Number	Input			Output			Efficiency (% Typ.)
	Voltage (VDC)			Voltage (VDC)	Current (mA)		
	Nominal	Range	Max.*		Max.	Min.	
WRA1205LT-2W	12	9-18	22	±5	±200	±20	74
WRA1212LT-2W				±12	±83	±8	78
WRA1215LT-2W				±15	±67	±7	78
WRB1203LT-1W6				3.3	500	50	70
WRB1205LT-2W				5	400	40	74
WRB1209LT-2W				9	222	22	76
WRB1212LT-2W				12	167	16	78
WRB1215LT-2W				15	133	13	79
WRA2405LT-2W				24	18-36	40	±5
WRA2412LT-2W	±12	±83	±8				78
WRA2415LT-2W	±15	±67	±7				78
WRB2403LT-1W6	3.3	500	50				72
WRB2405LT-2W	5	400	40				76
WRB2409LT-2W	9	222	22				78
WRB2412LT-2W	12	167	16				80
WRB2415LT-2W	15	133	13				80

\*Input voltage can't exceed this value, or will cause the permanent damage.

### MODEL SELECTION

WRB2412LT-2W

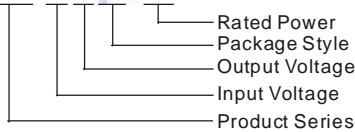

### MORNSUN America

43 Broad Street  
Hudson, MA 01749  
Tel: 978-567-9610  
Fax: 978-567-9601  
[Http://www.mornsunamerica.com](http://www.mornsunamerica.com)

### COMMON SPECIFICATIONS

Item	Test conditions	Min.	Typ.	Max.	Units
Storage humidity range				95	%
Operating temperature		-40		85	°C
Storage temperature		-55		125	
Temp. rise at full load			15		
Lead temperature	1.5mm from case for 10 seconds			245	
Short circuit protection		Continuous, automatic recovery			
Cooling		Free air convection			
Package material		Epoxy Resin (UL94-V0)			
MTBF		1000			K hours
Weight			5.2		g

ISOLATION SPECIFICATIONS					
Item	Test conditions	Min.	Typ.	Max.	Units
Isolation voltage	Tested for 1 minute and 1mA max.	1500			VDC
Isolation resistance	Test at 500VDC	1000			MΩ
Isolation Capacitance	Input/Output		85		pF

OUTPUT SPECIFICATIONS					
Item	Test conditions	Min.	Typ.	Max.	Units
Output power	See above products program	0.2		2	W
Positive voltage accuracy	Refer to recommended circuit		±1	±3	%
Negative voltage accuracy	Refer to recommended circuit		±3	±5	
Load regulation	From 10% to 100% load		±0.5	±1*	%
Line regulation	Input voltage from low to high		±0.2	±0.5	
Temperature Drift (Vout)	Refer to recommended circuit			±0.03	%/°C
Output ripple & noise**	20MHz Bandwidth		35	100	mVp-p
Switching frequency	100% load, nominal input voltage		300		KHz

\*Dual output models unbalanced load: ±5%.  
 \*\*Test ripple and noise by "parallel cable" method. See detailed operation instructions at Testing of Power Converter section, application notes.

## TYPICAL TEMPERATURE CUTVE

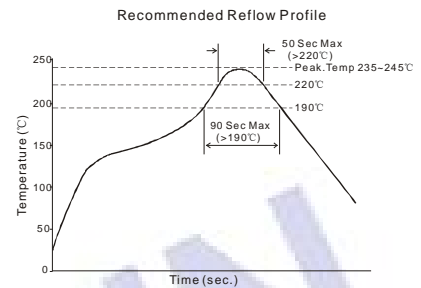
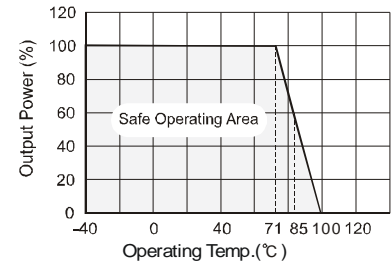

Remark:  
The curve applies only to the hot air reflow soldering

## APPLICATION NOTE

### Requirement On Output Load

In order to ensure the product operate efficiently and reliably, in addition to a max load (namely full load), a minimum load is specified for this kind of DC/DC converter. Make sure the specified range of input voltage is not exceeded, the minimum output load **no less than 10% load**. If the actual load is less than the specified minimum load, the output ripple may increase sharply while its efficiency and reliability will reduce greatly. If the actual output power is very small, please add an appropriate resistor as extra loading, or contact our company for other lower output power products.

### Recommended Circuit

All the WRA\_LT-2W & WRB\_LT-2W Series have been tested according to the following recommended testing circuit before leaving factory. This series should be tested under load. (See Figure 1).

If you want to further decrease the input/output ripple, you can increase capacitance properly or choose capacitors with low ESR. However, the capacitance of the output filter capacitor must be proper. If the capacitance is too big, a startup problem might arise. For every channel of output, provided the safe and reliable operation is ensured, the greatest capacitance of its filter capacitor sees (Table 1).

General: Cin: 12V 100μF  
 24V&48V 10μF~47μF  
 Cout: 10μF/100mA

### Input Current

When it is used in unregulated power supply, be sure that the fluctuating range of the power supply and the rippled voltage do not exceed the module standard. Input current of power supply should afford the flash startup current of this kind of DC/DC module. (Figure 2)

General:  $I_p \leq 1.4 \cdot I_{in-max}$

### No parallel connection or plug and play

## RECOMMENDED CIRCUIT

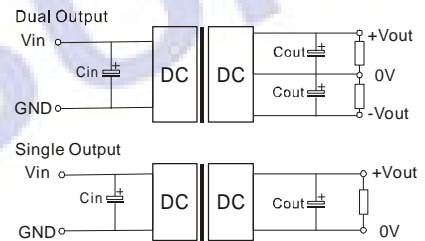

(Figure 1)

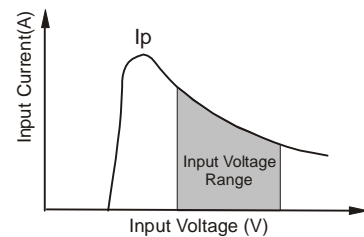

(Figure 2)

Output External Capacitor Table (Table 1)

Single Vout (VDC)	Cout (uF)	Dual Vout (VDC)	Cout (uF)
3.3	2200	±5	680
5	1000	±9	470
9	680	±12	330
12	470	±15	220
15	330	-	-

# OUTLINE DIMENSIONS & PIN CONNECTIONS

## MECHANICAL DIMENSIONS

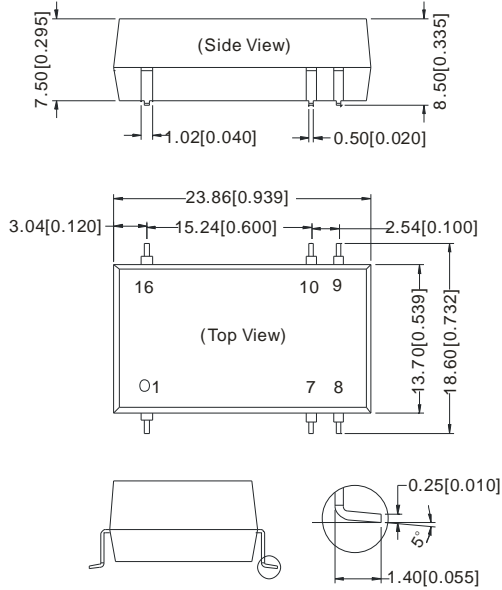

Note:  
 Unit:mm[inch]  
 Pin section tolerances:±0.10mm[±0.004inch]  
 General tolerances:±0.25mm[±0.010inch]

FOOTPRINT DETAILS		
Pin	Single	Dual
1	GND	GND
7	NC	NC
8	NC	0V
9	+Vo	+Vo
10	0V	-Vo
16	Vin	Vin

NC: No connection

## RECOMMENDED FOOTPRINT

### DUAL/SINGLE OUTPUT

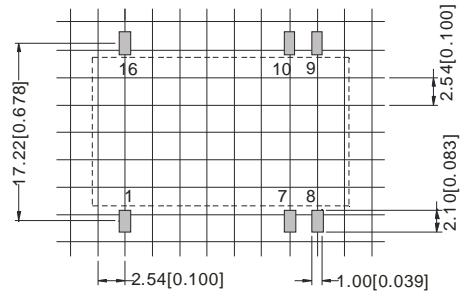

## TUBE OUTLINE DIMENSIONS

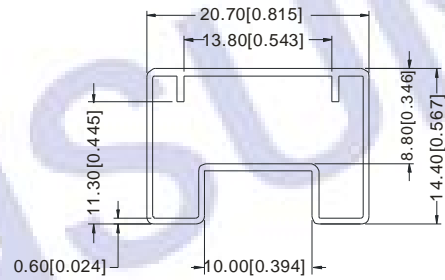

Note:  
 Unit :mm[inch]  
 General tolerances: ±0.50mm[±0.020inch]  
 L=530mm[20.866inch] Tube Quantity: 21pcs  
 L=220mm[8.661inch] Tube Quantity: 8pcs

### Note:

1. The load shouldn't be less than 10%, otherwise ripple will increase dramatically.
2. Operation under 10% load will not damage the converter; However, they may not meet all specification listed.
3. Capacitor MAX load tested at input voltage range and full load.
4. All specifications measured at Ta=25°C, humidity<75%, nominal input voltage and rated output load unless otherwise specified.
5. In this datasheet, all the test methods of indications are based on corporate standards.
6. Only typical models listed, other models may be different, please contact our technical person for more details.