

MORNSUN

IB_LT-1W Series

**1W, FIXED INPUT, ISOLATED & REGULATED
SINGLE OUTPUT SMD DC-DC CONVERTER**



RoHS

FEATURES

- Small Footprint
- SMD Package
- 1KVDC Isolation
- Temperature Range: -40°C to +85°C
- Internal SMD Construction
- Short Circuit Protection
- No Heat sink Required
- No External Component Required
- Industry Standard Pinout
- RoHS Compliance

APPLICATIONS

The IB_LT-1W Series are specially designed for applications where a group of polar power supplies are isolated from the input power supply in a distributed power supply system on a circuit board.

These products apply to:

- 1) Where the voltage of the input power supply is fixed (voltage variation $\leq \pm 5\%$);
- 2) Where isolation is necessary between input and output (isolation voltage $\leq 1000\text{VDC}$);
- 3) Where the regulation of the output voltage and the output ripple noise are not demanding.

MODEL SELECTION

IB0 512LT-1W

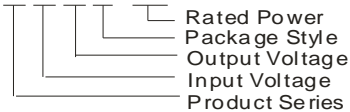

PRODUCT PROGRAM

Part Number	Input		Output			Efficiency (% Typ.)
	Voltage (VDC)		Voltage (VDC)	Current (mA)		
	Nominal	Range		Max.	Min.	
IB0505LT-W75	5	4.75-5.25	5	150	15	69
IB0509LT-1W			9	111	12	70
IB0512LT-1W			12	83	9	71
IB0515LT-1W *			15	67	7	72
IB1205LT-W75	12	11.4-12.6	5	150	15	69
IB1209LT-1W			9	111	12	70
IB1212LT-1W			12	83	9	71
IB1215LT-1W			15	67	7	72
IB1505LT-W75 *	15	14.25-15.75	5	150	15	69
IB1509LT-1W *			9	111	12	70
IB1512LT-1W *			12	83	9	71
IB1515LT-1W *			15	67	7	72
IB2405LT-W75	24	22.8-25.2	5	150	15	69
IB2409LT-1W *			9	111	12	70
IB2412LT-1W			12	83	9	71
IB2415LT-1W			15	67	7	72

*Designing

COMMON SPECIFICATIONS

Item	Test Conditions	Min.	Typ.	Max.	Units
Storage humidity				95	%
Operating temperature		-40		85	°C
Storage temperature		-55		125	
Temp. rise at full load			15	25	
Lead temperature	1.5mm from case for 10 seconds			260	
Cooling		Free air convection			
Short circuit protection		continuous			
Package material		Epoxy Resin (UL94-V0)			
MTBF		3500			K hours
Weight			2.9		g

ISOLATION SPECIFICATIONS

Item	Test Conditions	Min.	Typ.	Max.	Units
Isolation voltage	Tested for 1 minute and 1mA max	1000			VDC
Isolation resistance	Test at 500VDC	1000			MΩ
Isolation capacitance			70		pF

MORNSUN America

Address: 43 Broad Street
Hudson, MA 01749
Tel: 978-567-9610
Fax: 978-567-9601
<http://www.mornsunamerica.com>

OUTPUT SPECIFICATIONS

Item	Test Conditions	Min.	Typ.	Max.	Units
Output power		0.1		1	W
Line regulation	For Vin change of ±5%			±0.3	%
Load regulation	10% to 100% load			±1	
Output voltage accuracy	100% full load			±3	
Temperature drift	100% full load			0.03	%/°C
Ripple*	20MHz Bandwidth		10	20	mVp-p
Noise*	20MHz Bandwidth		50	150	
Switching frequency	Full load, nominal input		100		KHz

*Test ripple and noise by "parallel cable" method. See detailed operation instructions at Testing of Power Converter section, application notes.

TYPICAL CHARACTERISTICS

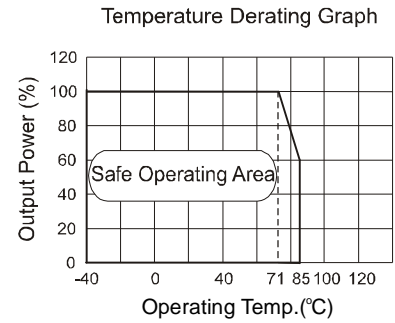

RECOMMENDED REFLOW SOLDERING PROFILE

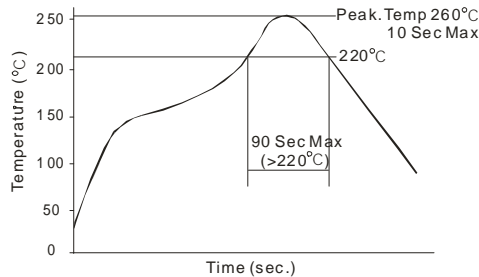

RECOMMENDED CIRCUIT

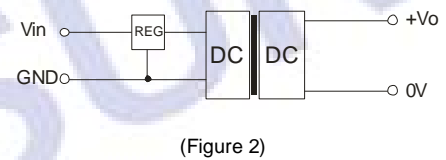
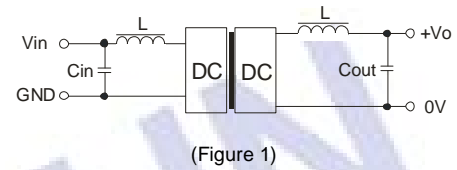

APPLICATION NOTE

1) Requirement on output load

To ensure this module can operate efficiently and reliably, During operation, the minimum output load is not less than 10% of the full load, and that this product should **never be operated under no load!** If the actual output power is very small, please connect a resistor with proper resistance at the output end in parallel to increase the load

2) Recommended circuit

If you want to further decrease the input/output ripple, an "LC" filtering network may be connected to the input and output ends of the DC/DC converter, see (Figure 1).

It should also be noted that the inductance and the frequency of the "LC" filtering network should be staggered with the DC/DC frequency to avoid mutual interference. However, the capacitance of the output filter capacitor must be proper. If the capacitance is too big, a startup problem might arise. For every channel of output, provided the safe and reliable operation is ensured, the greatest capacitance of its filter capacitor sees (Table 1).

EXTERNAL CAPACITOR TABLE (TABLE 1)

Vin (VDC)	Cin (uF)	Single Vout (VDC)	Cout (uF)
5	4.7	5	4.7
12	2.2	9	2.2
15	1	12	2.2
24	1	15	1

It's not recommended to connect any external capacitor in the application field with less than 0.5 watt output.

3) Overload Protection

Under normal operating conditions, the output circuit of these products has no protection against over-current. The simplest method is to connect a self-recovery fuse in series at the input end or add a circuit breaker to the circuit.

4) Input Over-voltage Protection Circuit

The simplest device for input over-voltage protection is a linear voltage regulator with overheat protection that is connected to the input end in series (Figure 2).

5) No parallel connection or plug and play

OUTLINE DIMENSIONS & PIN CONNECTIONS

MECHANICAL DIMENSIONS

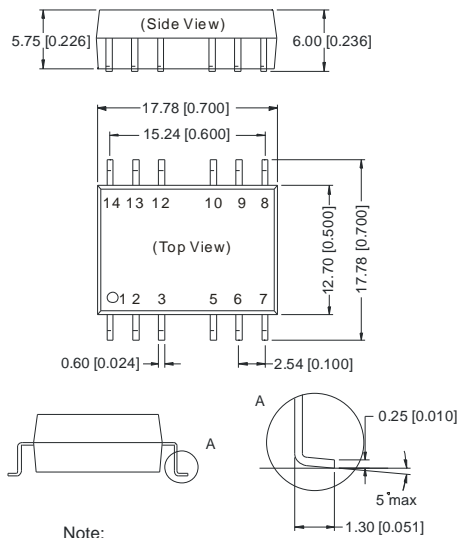

Note:
Unit: mm[inch]
Pin section tolerances: $\pm 0.10\text{mm}[\pm 0.039\text{inch}]$
General tolerances: $\pm 0.15\text{mm}[\pm 0.006\text{inch}]$

RECOMMENDED FOOTPRINT

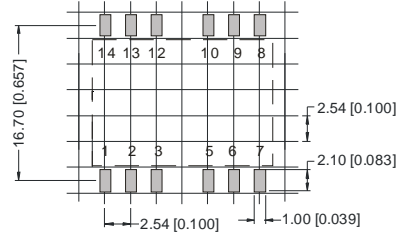

FOOTPRINT DETAILS	
Pin	Function
1	GND
2	V _{in}
6	0V
7	+V _o
Others	NC

NC: No Connection

TUBE OUTLINE DIMENSIONS

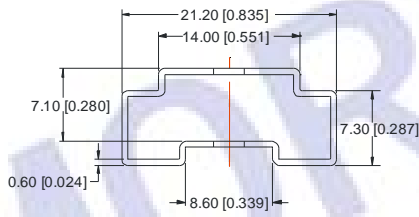

Note:
Unit: mm[inch]
General tolerances: $\pm 0.5\text{mm}[\pm 0.020\text{inch}]$
L=530mm[20.866inch] Tube Quantity: 28pcs
L=220mm[8.661inch] Tube Quantity: 10pcs

REEL PACKING OUTLINE DIMENSIONS

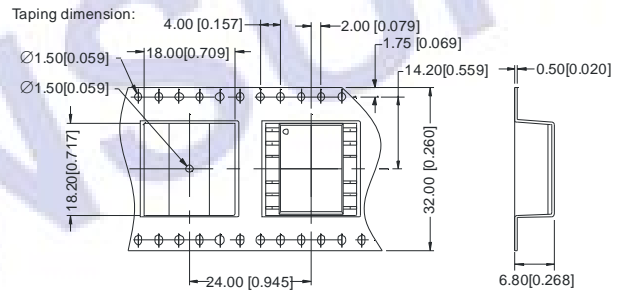

Taping reel dimension:

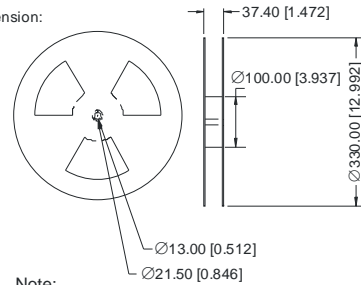

Note:
Unit: mm[inch]
General tolerances: $\pm 0.5\text{mm}[\pm 0.020\text{inch}]$
Devices per reel quantity: 400pcs

Note:

1. Operation under minimum load will not damage the converter; However, they may not meet all specification listed.
2. All specifications measured at Ta=25°C, humidity<75%, nominal input voltage and rated output load unless otherwise specified.
3. In this datasheet, all the test methods of indications are based on corporate standards.
4. Only typical models listed, other models may be different, please contact our technical person for more details.