

F_M-1W & F_N-1W Series

1W, FIXED INPUT, ISOLATED & UNREGULATED
SINGLE OUTPUT DC-DC CONVERTER

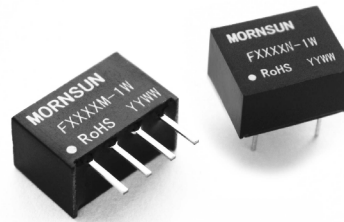

RoHS

FEATURES

High Efficiency up to 79%
3000VDC Isolation
Temperature Range: -40°C to+85°C
No Heatsink Required
No External Component Required
Internal SMD construction
Industry Standard Pinout
RoHS Compliance

APPLICATIONS

The F_M-1W & F_N-1W Series is specially designed for applications where a group of polar power supplies are isolated from the input power supply in a distributed power supply system on a circuit board.

These products apply to:

- 1) Where the voltage of the input power supply is fixed (voltage variation $\leq \pm 10\%$);
- 2) Where isolation is necessary between input and output (isolation voltage $\leq 3000\text{VDC}$);
- 3) Where the regulation of the output voltage and the output ripple noise are not demanding.

Such as: purely digital circuits, ordinary low frequency analog circuits, and IGBT power device driving circuits.

MODEL SELECTION

F0505N-1W

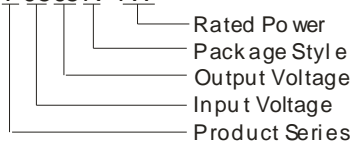

MORNSUN America

Address: 43 Broad Street
Hudson, MA 01749
Tel: 978-567-9610
Fax: 978-567-9601
<http://www.mornsunamerica.com>

PRODUCT PROGRAM

Part Number	Input		output			Efficiency (% Typ)	Package style
	Voltage (VDC)		Voltage (VDC)	Current (mA)			
	Nominal	Range		Min	Max		
F0303M -1W	3.3	3.0-3.6	3.3	300	30	70	SIP
F0305M/N -1W			5	200	20	73	SIP/DIP
F0503M/N -1W	5	4.5-5.5	3.3	300	30	71	SIP/DIP
F0505M/N -1W			5	200	20	69	SIP/DIP
F0509M/N -1W			9	111	12	76	SIP/DIP
F0512M/N -1W			12	83	9	78	SIP/DIP
F0515M/N -1W			15	67	7	78	SIP/DIP
F1203M/N -1W *			12	10.8-13.2	3.3	300	30
F1205M/N -1W	5	200			20	71	SIP/DIP
F1209M/N -1W	9	111			12	74	SIP/DIP
F1212M/N -1W	12	83			9	78	SIP/DIP
F1215M/N -1W	15	67			7	79	SIP/DIP
F2405N -1W	24	21.6-26.4	5	200	20	72	DIP
F2409N -1W			9	111	12	77	DIP
F2412N -1W *			12	83	9	77	DIP
F2415N -1W			15	67	7	79	DIP
F2424N -1W			24	42	3	78	DIP

* Designing.

ISOLATION SPECIFICATIONS

Item	Test conditions	Min	Typ	Max	Units
Isolation voltage	Tested for 1 minute and 1 mA max	3000			VDC
Isolation resistance	Test at 500VDC	1000			MΩ
Isolation Capacitance			60		pF

COMMON SPECIFICATIONS

Item	Test conditions	Min	Typ	Max	Units
Storage humidity				95	%
Operating Temperature		-40		85	°C
Storage Temperature		-55		125	
Temp. rise at full load			15	30	
Lead temperature	1.5mm from case for 10 seconds			300	
Short circuit protection*				1	S
Cooling		Free air convection			
Case material		Plastic (UL94-V0)			
MTBF			3500		K hours
Weight			4.3		g

*Supply voltage must be discontinued at the end of short circuit duration.

OUTPUT SPECIFICATIONS						
Item	Test conditions		Min	Typ	Max	Units
Output power			0.1		1	W
Line regulation	For Vin change of ±1%	(3.3V output)			±1.5	%
		(others output)			±1.2	
Load regulation	10% to 100% load	(3.3V output)		15	20	
		(5V output)		10	15	
		(9V output)		8.3	15	
		(12V output)		6.8	15	
		(15V output)		6.3	15	
		(24V output)		6.0	15	
Output voltage accuracy			See tolerance envelope graph			
Temperature drift	100% full load				0.03	%/°C
Ripple & Noise*	20MHz Bandwidth			100	150	mVp-p
Switching frequency	Full load, nominal input			100		KHz

*Test ripple and noise by "parallel cable" method. See detailed operation instructions at Testing of Power Converter section, application notes.
 Note:
 1. All specifications measured at TA=25°C, humidity<75%, nominal input voltage and rated output load unless otherwise specified.
 2. See below recommended circuits for more details.

TYPICAL CHARACTERISTICS

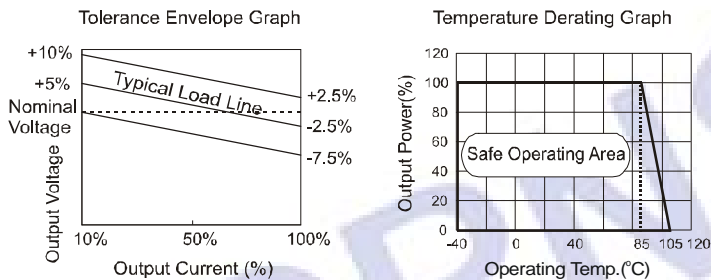

OUTLINE DIMENSIONS & PIN CONNECTIONS

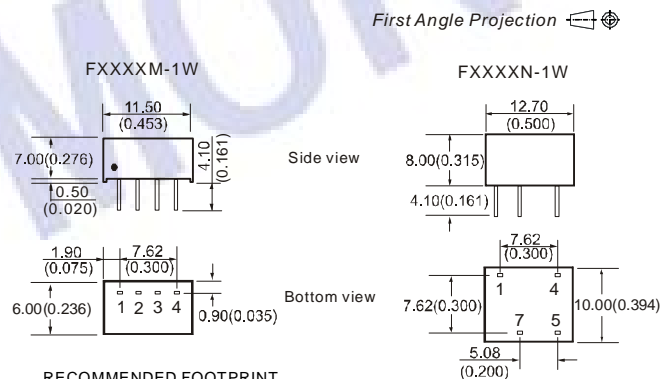

RECOMMENDED FOOTPRINT
 Top view, grid: 2.54mm (0.1inch), diameter: 1.00mm (0.039inch)

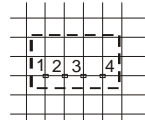

FOOTPRINT DETAILS

Pin	Function
1	GND
2	Vin
3	0V
4	+Vo

Note:
 Unit:mm (inch)
 Pin section: 0.50*0.30mm (0.020*0.012inch)
 Pin section tolerances: ±0.10mm (±0.004inch)
 General tolerances: ±0.25mm (±0.010inch)

Pin	Function
1	GND
4	Vin
5	+Vo
7	0V

APPLICATION NOTE

Requirement on output load

To ensure this module can operate efficiently and reliably, During operation, the minimum output load is **not less than 10%** of the full load, and that **this product should never be operated under no load!** If the actual output power is very small, please connect a resistor with proper resistance at the output end in parallel to increase the load, or use our company's products with a lower rated output power.

Recommended circuit

If you want to further decrease the input/output ripple, an "LC" filtering network may be connected to the input and output ends of the DC/DC converter, see (Figure 1).

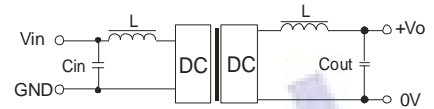

(Figure 1)

It should also be noted that the inductance and the frequency of the "LC" filtering network should be staggered with the DC/DC frequency to avoid mutual interference. However, the capacitance of the output filter capacitor must be proper. If the capacitance is too big, a startup problem might arise. For every channel of output, provided the safe and reliable operation is ensured, the recommended capacitance of its filter capacitor sees (Table 1).

EXTERNAL CAPACITOR TABLE (Table 1)

Vin (VDC)	Cin (uF)	Single Vout (VC)	Cout (uF)
3.3/5	4.7	3.3/5	10
12	2.2	9	4.7
24	1	12	2.2
-	-	15/24	1

It's not recommended to connect any external capacitor in the application field with less than 0.5 watt output.

Output Voltage Regulation and Over-voltage Protection Circuit

The simplest device for output voltage regulation, over-voltage and over-current protection is a linear voltage regulator with overheat protection that is connected to the input or output end in series (Figure 2).

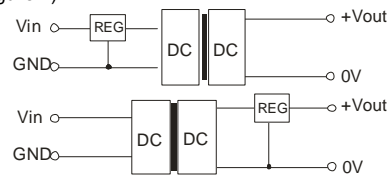

(Figure 2)

Overload Protection

Under normal operating conditions, the output circuit of these products has no protection against overload. The simplest method is to connect a self-recovery fuse in series at the input end or add a circuit breaker to the circuit.

No parallel connection or plug and play.