

MORNSUN

D_T-1W Series

**1W, FIXED INPUT, ISOLATED & UNREGULATED
TWIN OUTPUT ULTRAMINIATURE SMD PACKAGE
DC-DC CONVERTER**



RoHS

FEATURES

- Efficiency up to 80%
- Twin Independent Output
- Small Footprint
- SMD Package Styles
- Industry Standard Pinout
- No Heatsink Required
- 1kVDC Isolation
- High Power Density
- Temperature Range: -40°C ~ +85°C
- No External Component Required
- Internal SMD construction
- RoHS Compliance

APPLICATIONS

The D_T-1W series are specially designed for applications where a group of polar power supplies are isolated from the input power supply in a distributed power supply system on a circuit board. These products apply to:

- 1) Where the voltage of the input power supply is fixed (voltage variation $\leq \pm 10\%$);
- 2) Where isolation is necessary between input and output (isolation voltage $\leq 1000\text{VDC}$);
- 3) Where the regulation of the output voltage and the output ripple and noise are not demanding.

Such as: purely digital circuits, ordinary low frequency analog circuits and IGBT power device driven circuits, etc.

MODEL SELECTION

D050505T-1W

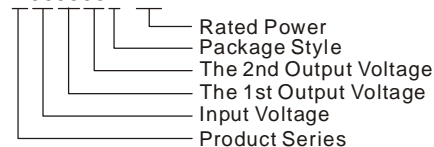

MORNSUN America

43 Broad Street
Hudson, MA 01749
Tel: 978-567-9610
Fax: 978-567-9601
[Http://www.mornsunamerica.com](http://www.mornsunamerica.com)

PRODUCT PROGRAM

Part Number	Input		Output			Efficiency (% Typ.)
	Voltage (VDC)		Voltage (VDC)	Current (mA)		
	Nominal	Range		Max.	Min.	
D050505T-1W	5	4.5-5.5	5/5	100/100	10/10	70
D050909T-1W *			9/9	56/56	6/6	75
D051212T-1W *			12/12	42/42	4/4	79
D051515T-1W *			15/15	33/33	3/3	80
D120505T-1W *	12	10.8-13.2	5/5	100/100	10/10	72
D120909T-1W *			9/9	56/56	6/6	75
D121212T-1W *			12/12	42/42	4/4	78
D121515T-1W *			15/15	33/33	3/3	80

*Designing.
Note: The D_T-W2/W5 series also are available in our company.

COMMON SPECIFICATIONS

Item	Test condition	Min.	Typ.	Max.	Units
Storage humidity				95	%
Operating temperature		-40		85	°C
Storage temperature		-55		125	
Temp. rise at full load			15	25	
Lead temperature	1.5mm from case for 10 seconds			260	
Short circuit protection*				1	s
Cooling		Free air convection			
package material		Epoxy Resin (UL94-V0)			
MTBF		3500			k hours
Weight			2.1		g

*Supply voltage must be discontinued at the end of short circuit duration.

ISOLATION SPECIFICATIONS

Item	Test condition	Min.	Typ.	Max.	Units
Isolation voltage (Vin/Vout)	Tested for 1 minute and 1mA max	1000			VDC
Isolation voltage (Vo1/Vo2)	Tested for 1 minute and 1mA max	1000			
Isolation resistance (Vin/Vout)	Test at 500VDC	1000			MΩ
Isolation resistance (Vo1/Vo2)	Test at 500VDC	1000			
Isolation capacitance (Vin/Vout)			60		pF
Isolation capacitance (Vo1/Vo2)			60		

OUTPUT SPECIFICATIONS

Item	Test Conditions	Min.	Typ.	Max.	Units
Output power		0.1		1	W
Line regulation	For Vin change of ±1%			±1.2	
Load regulation	10% to 100% load(5V output)		12.8	15	%
	10% to 100% load(9V output)		8.3	10	
	10% to 100% load(12V output)		6.8	10	
	10% to 100% load(15V output)		6.0	10	
Output voltage accuracy	See tolerance envelope graph				
Temperature drift	100% full load			±0.03	%/°C
Ripple & Noise*	20MHz Bandwidth		50	75	mVp-p
Switching frequency	Full load, nominal input		100		kHz

*Test ripple and noise by "parallel cable" method. See detailed operation instructions at Testing of Power Converter section, application notes.

RECOMMENDED REFLOW SOLDERING PROFILE

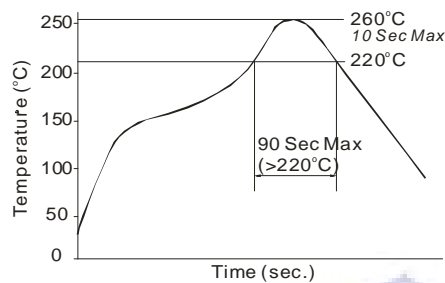

Remark: The curve applies only to the hot air reflow soldering

TYPICAL CHARACTERISTICS

1) Requirement On Output Load

To ensure this module can operate efficiently and reliably, a minimum load is specified for this kind of DC/DC converter in addition to a maximum load (namely full load). During operation, make sure the specified range of input voltage is not exceeded, the minimum output load is **not less than 10% of the full load**, and that this product should **never be operated under no load!** If the actual output power is very small, please connect a resistor with proper resistance at the output end in parallel to increase the load, or use our company's products with a lower rated output power (D_T -W2/W5).

2) Recommended testing circuit

If you want to further decrease the input/output ripple, an "LC" filtering network may be connected to the input and output ends of the DC/DC converter, see (Figure1).

It should also be noted that the inductance and the frequency of the "LC" filtering network should be staggered with the DC/DC frequency to avoid mutual interference. However, the capacitance of the output filter capacitor must be proper. If the capacitance is too big, a startup problem might arise. For every channel of output, provided the safe and reliable operation is ensured, the greatest capacitance of its filter capacitor sees (Table 1).

3) Output Voltage Regulation and Over-voltage Protection Circuit

The simplest device for output voltage regulation, over-voltage and over-current protection is a linear voltage regulator with overheat protection that is connected to the input or output end in series (Figure2).

4) Overload Protection

Under normal operating conditions, the output circuit of these products has no protection against overload. The simplest method is to connect a self-recovery fuse in series at the input end or add a circuit breaker to the circuit.

5) No parallel connection or plug and play.

APPLICATION NOTE

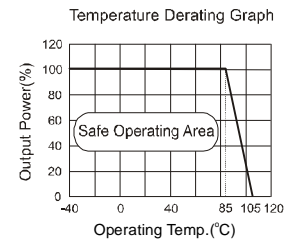
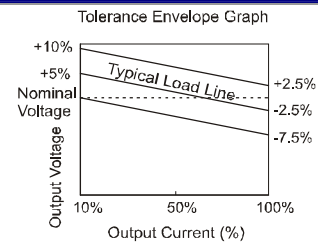

RECOMMENDED CIRCUIT

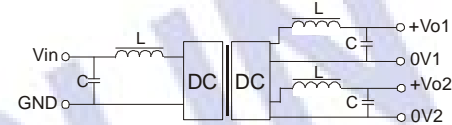

(Figure 1)

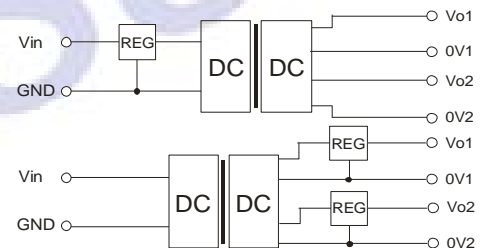

(Figure2)

EXTERNAL CAPACITOR TABLE (TABLE 1)

Vin (VDC)	Cin (μF)	Vout (VDC)	Cout (μF)
5	4.7	5	4.7
12	2.2	9	2.2
-	-	12	1
-	-	15	0.74

It's not recommended to connect any external capacitor in the application field with less than 0.5 watt output.

OUTLINE DIMENSIONS & RECOMMENDED FOOTPRINT

MECHANICAL DIMENSIONS

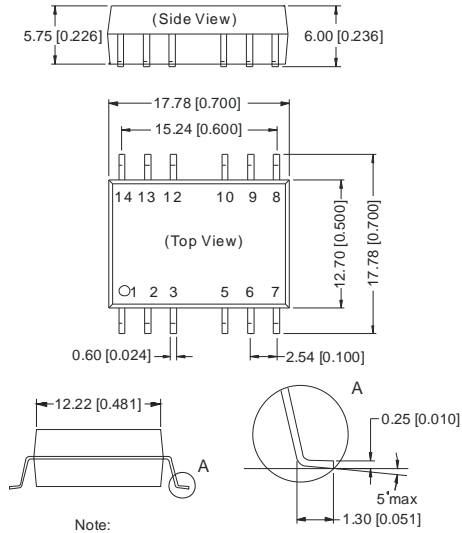

Note:
Unit: mm[inch]
Pin section tolerances: $\pm 0.10\text{mm}$ [$\pm 0.004\text{inch}$]
General tolerances: $\pm 0.25\text{mm}$ [$\pm 0.010\text{inch}$]

RECOMMENDED FOOTPRINT

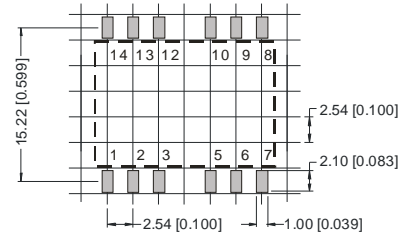

FOOTPRINT DETAILS	
Pin	Function
1	GND
2	Vin
5	0V1
6	Vo1
9	Vo2
10	0V2
Others	NC

NC: No Connection

TUBE OUTLINE DIMENSIONS

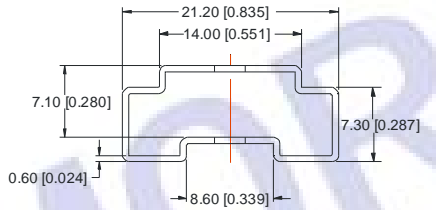

Note:
Unit: mm[inch]
General tolerances: $\pm 0.5\text{mm}$ [$\pm 0.020\text{inch}$]
L=530mm[20.866inch] Devices per tube quantity: 28pcs
L=220mm[8.661inch] Devices per tube quantity: 10pcs

REEL PACKING OUTLINE DIMENSIONS

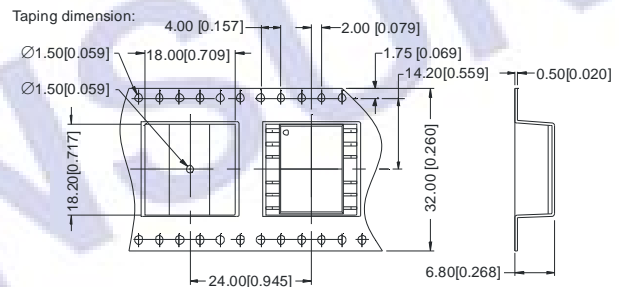

Taping reel dimension:

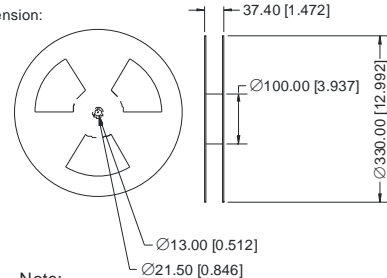

Note:
Unit: mm[inch]
General tolerances: $\pm 0.5\text{mm}$ [$\pm 0.020\text{inch}$]
Devices per reel quantity: 400pcs

Note:

1. Operation under minimum load will not damage the converter; However, they may not meet all specification listed.
2. All specifications measured at $T_a=25^\circ\text{C}$, humidity<75%, nominal input voltage and rated output load unless otherwise specified.
3. Only typical models listed, other models may be different, please contact our technical person for more details.
4. In this datasheet, all the test methods of indications are based on corporate standards.